

Uni-Blinds®

Innovation comes built-in

BRINGING GLAZING TO LIFE.

Morley
GLASS & GLAZING LTD



ScreenLine® A brand of
pellinindustrie

INNOVATION COMES BUILT IN



Bringing Glazing to Life.

With a passionate commitment to customer service, Morley Glass is the name thousands of customers know they can depend on for high quality glazing, sealed units and integral blinds.

We utilise the most advanced processing technology and, combined with a rigorous quality control system, we manufacture products to the highest standard. That gives us the confidence to offer amongst the longest guarantees in the industry.

Our manufacturing excellence is recognised by the fact that we are the only company in the UK licensed to manufacture Screenline® blinds in-house. The highly innovative Uni-Blinds® integral blind systems from Screenline® can be operated manually or electronically. Uni-Blinds® integral blinds eliminate the need for cleaning and maintenance and offer a comprehensive selection of colour-ways and operational systems.

Our integrity is supported through our membership of the British Blind and Shutter Association (BBSA) – we are in fact the only integral blind manufacturer to have this distinguished membership. All our units are manufactured to the exacting standards laid down by the CEN Solutions BS EN 1279.

One of the keys to our success is our dedication to building long term relationships with industry-leading suppliers. By having this supply chain excellence, we can deliver on our promise of superb quality products. That's why we work only with international suppliers we can trust, and who are leaders in their respective fields including Pellini S.p.A., Glassolutions Saint-Gobain and Ritec.

Introducing our place



OUR PLACE



OUR BLINDS



Above Outside Pellini Industries, Codogno, Milan.

ITALIAN STYLE AND QUALITY

pelliniindustrie

About Pellini

Our ScreenLine® range of integral blind systems is manufactured in Italy by Pellini S.p.A. The family-run business was founded in 1974 and its commitment to quality craftsmanship and innovation has resulted in technically advanced, high performance products that you can rely on.

ScreenLine® by Pellini S.p.A, develops and manufactures sun shading systems to be encapsulated within double glazing units, which allow the problem of light and heat gain in buildings to be solved by means of long lasting and maintenance free solutions.

The blind is operated in a totally sealed environment, protected from dust, dirt or weather conditions; the characteristics of traditional double glazing units are preserved, leaving unaltered the hermetic properties of the cavity. All this is made meeting the requirements of the current standards in term of energy performances of buildings. Over the years, ScreenLine® has achieved a high number of significant patents, applying them in a wide range of products designed to meet every need related to sun shading: variety of colours, screening, operation and versatility of application.



Above SL27MB motorised blind.





pelliniindustrie



Above Pellini factory, Codogno, Italia.

UNRIVALLED

Being permanently sealed within the cavity of the double glazed units makes Uni-blinds® unrivalled in the control of light and shade, and the only viable option for light control in bi-folding and sliding doors. The integral blind system ensures that you have one of the safest blind systems available.*



*Window blind cords and chains can pose a risk for babies, children and vulnerable people who could injure or even strangle themselves on the hanging looped cords. This potential problem is eliminated by the use of Uni-Blinds®, as the blind is inside the double glazed unit, so effectively away from any misuse or danger. In our corded systems we use an external continuous cord loop that is held permanently against the glass, eliminating any chance of the cord hanging in a loose loop which could be dangerous. Conforms to EN13120 for cord safety.



ONE CONCEPT FIVE CONTROL SYSTEMS ONE LEAD TIME

10 days from 11am on any Friday*



*Except Bank Holidays
**Please check web clock weekly on
www.morleyglass.co.uk



C SYSTEM: MAGNETIC MANUAL CONTROL (BY CORD, ROTATION KNOB OR WAND)

All our Uni-Blinds® systems feature the world's number one integral blind system ScreenLine®. The SL20-22C is a patented magnetic system with manual operation (raising and tilting function) for Venetian blinds incorporated within 20mm, 22mm or 27mm insulating glass units. The external magnetic device, applied on the glass by means of high-resistance adhesive tape contains a cord loop and a magnet that is perfectly interfaced with the magnetic joint of the internal drive, which is completely housed inside the head rail. The cord is kept under tension by means of a special cord tensioner applied to the glass. This magnet principle does not compromise the unit seal and guarantees the integrity of the double-glazing unit.



SV SYSTEM: CORDLESS SLIDER

The ScreenLine® SL20SV system is a manually operated sliding Venetian or pleated blind which features a single, cleverly designed magnetic slider to control the whole operation. Positioned on a narrow slide guide on the edge of the sealed unit, the cordless magnetic slider allows the blind to be raised, lowered and tilted effortlessly.



S SYSTEM: SLIDER

The ScreenLine® SL20-22S is a manual system comprising a 14mm pleated blind integrated within a double glazed unit with 20mm or 22mm cavity. The blind movement is achieved by a magnetic device positioned centrally on the outer surface of the internal pane sliding across the glass surface. This external magnet interfaces with a similar internal magnet located in the movable head rail to absorb possible glass deflections. The blind can be adjusted at any inclination and raised in all directions, making it an ideal system for attic, dormer and skylight applications.

Available in 16 exclusive colours from Morley Glass & Glazing.



W SWIPE SYSTEM: SOLAR POWERED

The SL20-22W-Swipe Uni-Blinds® system with ScreenLine® inside is a battery operated, motorised blind system. With this system, a Venetian or pleated blind encapsulated within a double glazed unit can be raised or lowered via a control device magnetically attached to the window or, more comfortably, by remote control. The system operates with standard, long-life rechargeable batteries and is equipped with a cleverly designed external energy saving solar panel. The system can be fitted quickly and easily and can be applied to all types of window frames, even existing ones. No wires or electrical contacts are required and internal glass thickness is irrelevant. It is equally suitable for residential and commercial environments as it needs no maintenance.

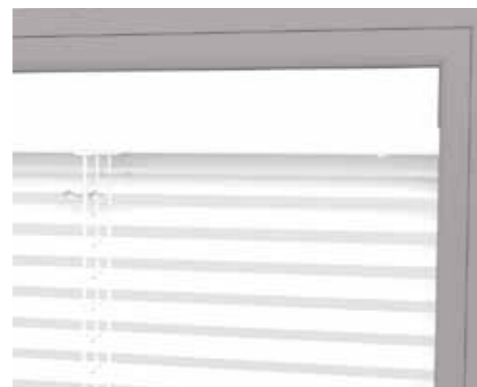

MB SYSTEM: MOTORISED BRUSHLESS

The addition of a brushless motor is a significant improvement on previous electrical systems used for raising/lowering and tilting integral Venetian or pleated blinds. It allows (by means of an encoder) the simultaneous and synchronised operation of several blinds and the accurate tilting of the slats. No other control device is applied on glass or window frame, since the motor is activated by means of wall-mounted push buttons or remote control (options). Manufactured from high quality materials, coupled with the purity of aesthetic appearance and technical excellence, the SL20-22 27 MB system is particularly suited to prestigious projects, especially the exclusive contemporary domestic market.

ONE CONCEPT FIVE CONTROL SYSTEMS ONE ENERGY EFFICIENCY BAR



Energy efficiency, built-in

All Uni-Blinds® feature a warm edge spacer bar to ensure the thermal insulation of the sealed unit is maximised.

This stainless steel spacer bar is co-extruded with polypropylene to enhance the benefits of all ScreenLine® integral blinds systems with energy saving qualities – all within the perfect hermetic seal. Reduces the generation of humidity on the glass perimeter. Improves the thermal insulation of the profile due to its low thermal conductivity. Ensures a low Psi value (halving heat transmission through the perimeter compared to a standard extruded aluminium spacer bar). Reduces the thermal transmittance value of the window, irrespective of the material used for the frame.

It's the only integral blind system with a warm edge spacer bar and is available in black as standard or light grey upon request.

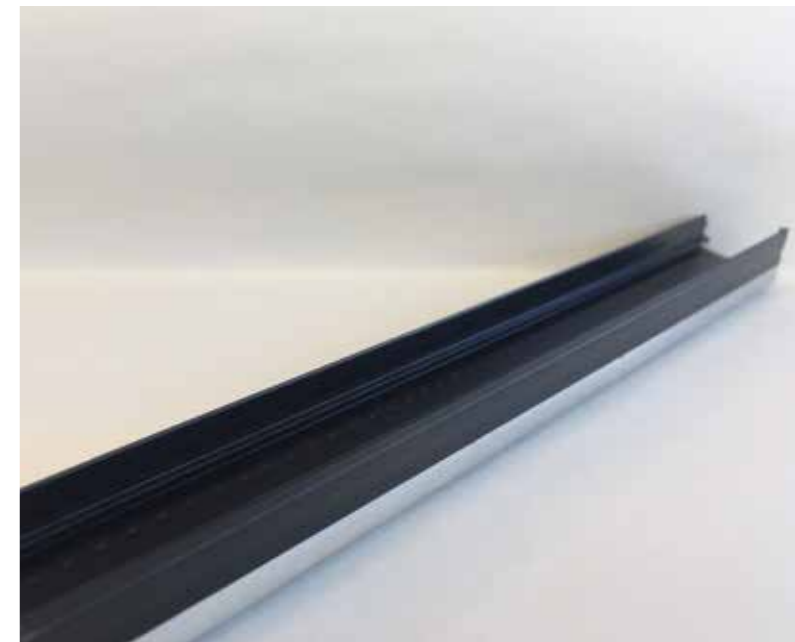

Above Black standard colour.

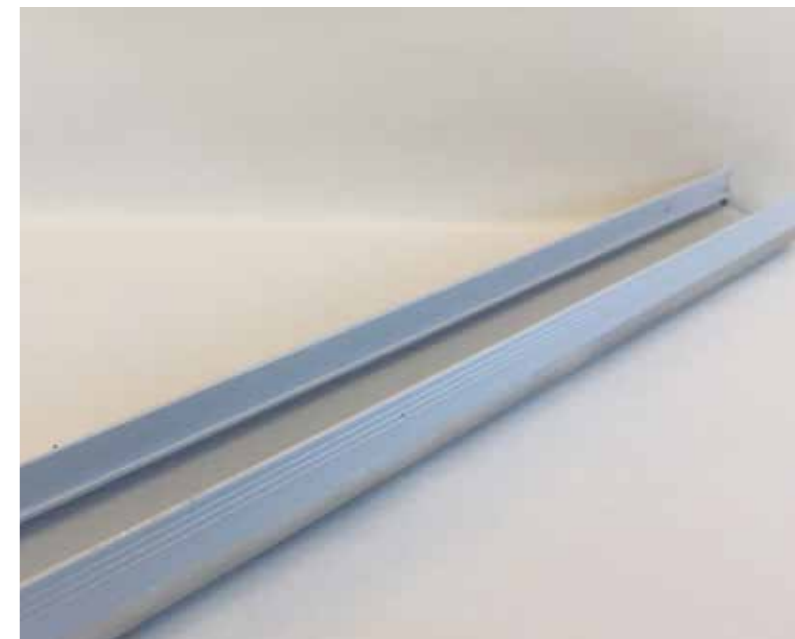

Above Light Grey optional.

COLOUR YOUR WORLD

Will they match my colour scheme?

Uni-Blinds® come in a range of colours, with Venetian blinds being available in 10 colours and Pleated blinds available in 18 colours to complement your chosen colour scheme.

Swatches available on request.

VENETIAN COLOURS

S102 WHITE
Standard

S102 WHITE
Solar reflection 70%
Light reflection 78%
Solar absorption 30%
Standard colour

S125 BEIGE

S125 BEIGE
Solar reflection 57%
Light reflection 63%
Solar absorption 43%

S142 LIGHT BLUE

S142 LIGHT BLUE
Solar reflection 65%
Light reflection 69%
Solar absorption 35%

S106 YELLOW

S106 YELLOW
Solar reflection 62%
Light reflection 72%
Solar absorption 38%

S130 GREEN

S130 GREEN
Solar reflection 58%
Light reflection 65%
Solar absorption 42%

S149 CREAM
Standard

S149 CREAM
Solar reflection 68%
Light reflection 75%
Solar absorption 32%
Standard colour

S155 GREY

S155 GREY
Solar reflection 42%
Light reflection 48%
Solar absorption 59%

S157 SILVER
Standard

S157 SILVER
Solar reflection 43%
Light reflection 44%
Solar absorption 57%
Standard colour

S156 METALLIC SILVER
Standard

S156 METALLIC SILVER
Solar reflection 65%
Light reflection 62%
Solar absorption 35%

S159 ANTHRACITE
Exclusive

S159 ANTHRACITE
Solar reflection 12%
Light reflection 13%
Solar absorption 88%

EXCLUSIVE TO MORLEY GLASS

PLEATED COLOURS*

C100

C100
Light reflection 45%
Light transmission 50%
Absorption 5%

C024

C024
Light reflection 15%
Light transmission 17%
Absorption 68%

C131

C131
Light reflection 16%
Light transmission 13%
Absorption 71%

C117

C117
Light reflection 39%
Light transmission 40%
Absorption 21%

C130

C130
Light reflection 17%
Light transmission 11%
Absorption 72%

C010

C010
Light reflection 40%
Light transmission 46%
Absorption 14%

C025

C025
Light reflection 12%
Light transmission 17%
Absorption 68%

C145

C145
Light reflection 11%
Light transmission 15%
Absorption 74%

C235

C235
Light reflection 9%
Light transmission 6%
Absorption 85%

C331

C331
Light reflection 14%
Light transmission 9%
Absorption 77%

C013

C013
Light reflection 12%
Light transmission 14%
Absorption 74%

C041

C041
Light reflection 11%
Light transmission 9%
Absorption 80%

C165

C165
Light reflection 13%
Light transmission 8%
Absorption 79%

C276

C276
Light reflection 12%
Light transmission 17%
Absorption 71%

C700

C700
Light reflection 6%
Light transmission 5%
Absorption 89%

C023

C023
Light reflection 38%
Light transmission 38%
Absorption 24%

C042

C042
Light reflection 13%
Light transmission 12%
Absorption 75%

C175

C175
Light reflection 15%
Light transmission 15%
Absorption 70%

*Vanity pleated colours are all exclusive to Morley Glass.

C System: Manual Control

MANUAL CONTROL LIGHT AND SHADE WITH THE C SYSTEM

**DELIVERED EXCLUSIVELY
WITHIN 10 WORKING DAYS***

The SL20C system is manufactured in accordance with the highest technical specifications and production standards. The slat raising, lowering and tilting function is achieved using a rotational magnetic transmission through the glass thereby guaranteeing the unit's hermetic seal. We are the only UK company able to supply this system within 10 working days for an order placed before 11am on a Friday.*

*Based on order placed on a Friday before 11am.
Subject to Italian and english bank holidays



Blinds open



Blinds partially closed



Blinds fully closed



Cord system



Rotational wand



Wand

Main Features

- Suitable for all vertical window applications
- Ideal solution for conservatory shading
- Total privacy and light control
- Gives excellent utilisation of partitioned office space
- Suitable for retro installation into existing frames
- Only viable option for bi-folding doors

C System: Manual Control



The external magnet, fixed to the internal glass by double sided high performance adhesive, allows perfect alignment with the internal magnet. Raising and lowering is controlled using a continuous cord loop that drives the external magnet. The cord is held lightly under tension by a cord tensioner and fully complies with 'make it safe'.



DESIGNED TO MAXIMISE YOUR OPTIONS FOR LIGHT AND SHADE CONTROL

Be in full control of the light in your home

So how are they actually operated? There are several different ways in which they work, and it is really down to preference. Venetian Blinds can be operated by a rotational cord winder attached at the top of the room-facing pane of the double glazed unit (as can be seen in the picture), or by a 'wand' (a small pole attached at the top to the room-facing pane of the double glazed unit) which is twisted to open and close the blind.



*Campaign in association with the British Blind and Shutter Association code of practice

FULLY AUTOMATED PRECISION CONTROL WITH THE MB SYSTEM

Manufactured using high quality materials, this technically excellent system looks great whilst operating to the highest standard. The electric brushless motor quietly raises, lowers and tilts the integral blinds safely, smoothly and with precision. This system is ideal for exclusive domestic properties encapsulated within 20, 22 and 27mm cavity double glazed units.

The motorised Venetian or pleated blind has an internal motor integrated within the blind head-rail and incorporates a micro-control unit plus encoder, which allows simultaneous, synchronised movements of groups of blinds.

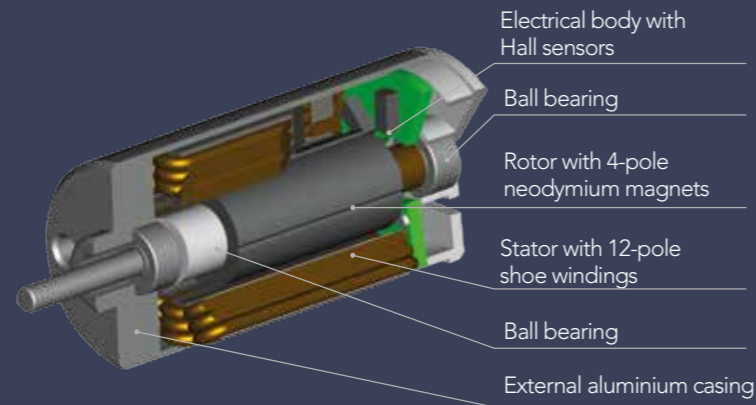

Feasibility chart

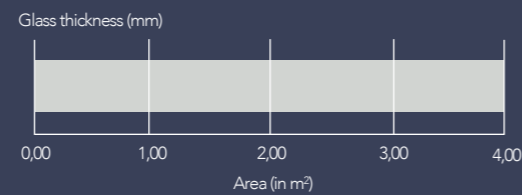

Possible dimensions

W min = 300mm W max = 2000mm
H min = 300mm H max = 2600mm

Maximum height possible according to width

with W = from 300 to 350mm Max H = 1670mm*
with W = from 351 to 400mm Max H = 2020mm*
with W = from 401 to 2000mm Max H = 2600mm**

* Up to 2600mm (H), blind supplied with tilt-only function and locked bottom rail
** For areas from 4.01m² to 5.2m², blind supplied with tilt-only function and completely raised



Morley Glass has developed a unique control box for motorised blinds which eliminates installation issues and provides an aesthetically pleasing solution for control at your fingertips. The control boxes are supplied pre-wired and fully tested, making for a smooth problem-free installation. Integration with home automation systems is also possible.



Manufactured from high quality materials, coupled with the purity of aesthetic appearance and technical excellence, the system is particularly suited to prestigious projects, especially the exclusive contemporary domestic market. And now exclusively supplied in 10 working days when ordered on a Friday.

Control at your fingertips

For the discerning homeowner who prefers the speed and synchronicity of an automated home, Uni-Blinds® can be operated via the flick of a switch or by RF remote control.





IT'S CHILD PLAY

Morley launches smart solution for Home Automation Integration

Uni-blinds® integral blinds manufacturer Morley Glass & Glazing has developed SmartMotion, a unique interface that helps installers quickly and easily incorporate its motorised integral blinds into home automation systems.

The global home automation market was valued at \$4.41 billion in 2014 and is set to grow by 26.3% by 2020. Home automation systems integrate various domestic applications such as lighting, heating, safety and security, energy management, entertainment systems – and motorised integral blinds – and are growing in popularity in the UK, as the concept of “smart” homes takes off.

An increasing number of our customers are being asked to incorporate our motorised Uni-blinds® integral blinds into electric-powered home automation systems – and in the past it has been a daunting and a complex task that could cause damage to the wiring of the blinds or the home automation system.

This inspired us to commission the development of a unique interface called the SmartMotion which makes the process so simple it's child's play. In one easy step the operation of the blinds is smoothly integrated into the whole home automation system so that they can be controlled at the touch of a button, even when you're not at home.

The SmartMotion is exclusive to Morley Glass & Glazing and is compatible with the MB System of Uni-Blinds®, which operate using an electric brushless motor. It is supplied pre-wired and fully tested, making for a smooth, problem-free installation.



Smart motion control box

For more information, visit www.morleyglass.co.uk

W Swipe: Solar powered

WIRE-FREE SOLAR POWERED, ECO-FRIENDLY SIMPLICITY WITH THE **W SWIPE**

The latest in innovative and ecological Italian design, the W Swipe is a battery operated, motorised blind system utilising Venetian or pleated blinds, encapsulated within a 20, 22 or 27mm cavity double glazed unit.

The encapsulated blind is raised and lowered, and in the case of the Venetian blind, slat-tilted via a discreet slide button control which is magnetically attached to the double glazed unit.



OUR NEW W SWIPE BATTERY PACK

SL2380 Battery Module -
available in:
anthracite grey S159

Benefits

- Streamlined installation procedure
- No need for electrician to install
- Hard-wired power supply not required
- Energy saving
- For 20, 22 and 27mm cavity, in Venetian and pleated versions
- Small sized battery module, developed in co-operation with design specialists
- Touch control keys
- Radio remote control supplied as standard
- Batteries can be easily replaced.



The W SWIPE is powered and charged via an external solar panel

The system is powered by standard long-life rechargeable batteries and is supplied with a cleverly designed battery charger. A remote control option is also available.

As well as private and domestic situations, this system is particularly suited to commercial installations such as medical and educational environments, offices, schools and colleges.



PLEATED BLINDS: A HIGH PERFORMANCE ALTERNATIVE

Our range of stylish pleated blinds are manufactured from woven polyester fabric in a wide range of colour options so they're able to perfectly complement any interior. Allowing a soft diffusion of light, integral pleated blinds are an attractive, elegant blind solution with a number of practical benefits. A stylish blind style, pleated blinds benefit from their ability to fold neatly away to provide you with clear views – perfect for any window or conservatory.



A double glazing unit with integrated Uni-Blinds® is an excellent screen against solar radiation and offers the possibility to quickly and easily adjust the internal environmental lighting level. Due to the glass transparency, the use of standard double glazing units is often not enough to guarantee correct control of solar energy.

A Uni-Blinds® integrated system filters the light and affects its value by the tilting of the slats (in the case of Venetian blinds) or by lowering the blind (in the case of pleated blinds). Temperature and visual comfort are improved according to the various seasons.



SL20SP Plissé



SL20 Plissé

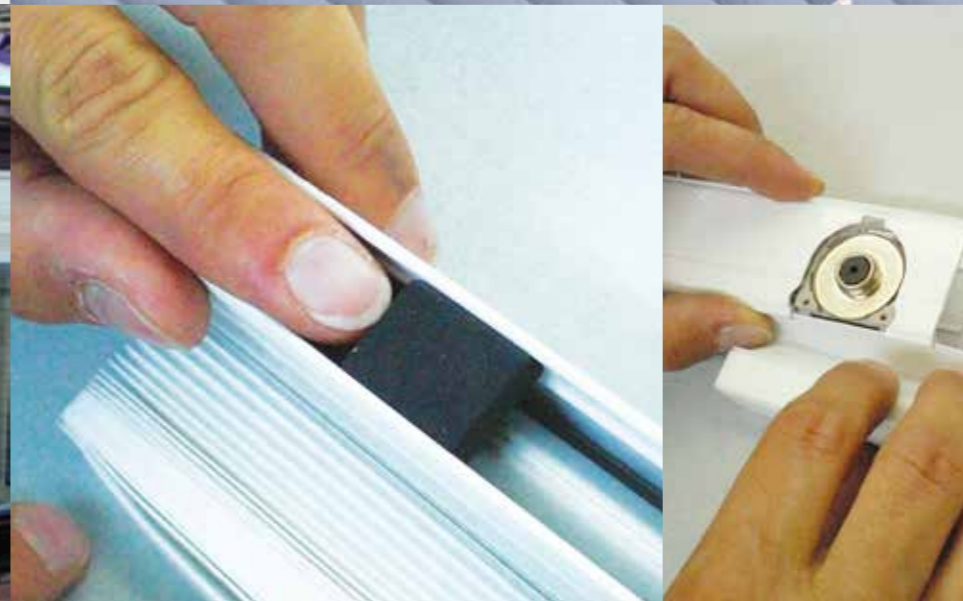

We manufacture and distribute nationwide

Our exclusive contract to manufacture integral pleated SP and S System Uni-Blinds® in the UK, gives us the unprecedented capability to manufacture and distribute nationwide within five working days. Our operatives have been trained in Italy to manufacture this market leading product to the exacting standards required.

SLIDER CONTROL WITH S PLEATED BLINDS

Great for conservatories

This manual system comprises a 14mm pleated blind integrated within a double glazed unit with 20mm cavity. The blind movement is achieved by sliding a magnetic device positioned centrally on the outer surface of the internal pane across the glass surface.

This external magnet interfaces with a similar internal magnet located in the movable head-rail and it is so designed to absorb possible glass deflections.



The application of Verosol pleated blind fabrics, coated with an aluminium layer on one side, reduces solar heat gain and improves the U-value, whilst regulating the light passing through. Light transfer down the blind edge is eliminated by the use of special "L" shaped-side guides.

The S System is an extremely versatile product with simplicity of control; the blind can be adjusted to any position at any inclination from 0° (horizontal) to 90° (vertical). The blind can be moved in every direction; from right to left, from left to right, from the top to the bottom and vice versa.

The system is also highly modular; the basic model is installed in a 20mm cavity. It is possible to install two blinds within the same unit. The seal integrity is not compromised in the S System.

The special features and the high product quality are an effective solution to the problem of light and heat regulation in garret/attic environments, providing an easy and lasting solution of shading for roof windows, whatever the angle.

SLIDER CONTROL VENETIAN BLINDS



Slide guide and head rail colours



White Beige Grey Anthracite

External slider colour range



White Beige Grey Anthracite

Raising

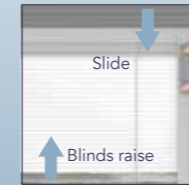

Lowering

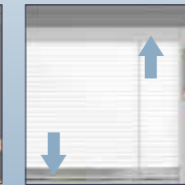
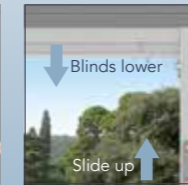

Tilting

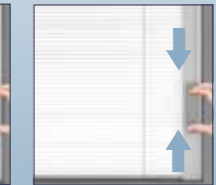

This Venetian blind system is manually-operated and utilises a patented magnetic device to operate the blinds encapsulated within 20mm cavity double glazing units.

A magnetic slider, placed on the right or left-hand edge of the glass, allows the slats to be raised and tilted. The external slider 'logically' moves in the same direction as the blind operating direction. The blind is raised and lowered by moving the slider down or up and is tilted by slightly lifting or lowering the same slider.

The system can be applied to all types of window frames, even sliding ones, owing to the slim design of the control device. Equipped with a warm edge spacer bar as standard the SV System offers high energy performance and, consequently, savings on heating and air conditioning costs.

SL20SV CORDLESS SLIDER BENEFITS

- Closed-loop belt transmission system allows smooth and long-lasting function of the blind
- The external magnetic slider is treated with the Sanitized® patented antibacterial finish, which provides a long-lasting protective function
- The patented warm edge spacer bars and the plastic side profile improve the energy performance of the insulating glass unit
- Meets the requirements of child safety standards
- Only one device is used to raise and tilt the slats.

A stylish blind style, pleated blinds benefit from their ability to fold neatly away to provide you with clear views – perfect for any window or conservatory.

SL20S Venetian

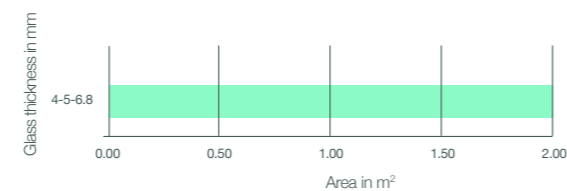

Possible dimensions:

W min = 300 mm	W max = 1500 mm
H min = 600* mm	H max = 2200 mm

* 300 mm with tilt-only blind (SL20SA)

Feasibility notes

Maximum height possible according to width

with W from 300 to 350 mm	H max = 1400 mm*
with W from 351 to 550 mm	H max = 1800 mm*
with W from 551 to 1500 mm	H max = 2200 mm**

* Up to H = 2200 mm, blind supplied with tilt-only function and locked bottom rail (SL20SA)
 ** For areas from 2.01 m² to 3.3 m², blind supplied with tilt-only function and completely raised

- ✓ Hygienic
- ✓ Energy saving
- ✓ Stylish design
- ✓ Patented technology
- ✓ Peace of mind
- ✓ Fitting versatility
- ✓ BBSA Safe
- ✓ User friendly



Hygiene

The external magnetic slider is treated with the Sanitized® patented antibacterial finish. The active biocidal substance contains silver ions to provide a long-lasting protective function.

Energy

The patented warm edge spacer bars and the plastic side profile improve the energy performance of the insulating glass unit. This delivers the best of both worlds – stylish doors and windows which save energy too.

Patented technology

Innovation goes to the core of the SL20SV with a patent pending system of internal cord winding on the tube which considerably reduces the blind friction.

Design

The slider and the external guide were developed in co-operation with professional designers for superior aesthetics. This delivers superb looking doors and windows every time.

Lifespan

The closed-loop belt transmission system allows smooth and long-lasting function of the blind for total reliability and peace of mind.

Versatility

Applicable to all types of door and window frames, even sliding ones, thanks to the slim dimensions of the control device.

User friendly

Only one device is used to raise and tilt the slats.

Safety

Meets the requirements of child safety standards as recommended by the BBSA.



Protected with Sanitized® Active biocidal substance: silver ions.

UNI-BLINDS® AT THE FOREFRONT OF BLIND SAFETY

A primary consideration of family living space must always be safety. As would be expected from the UK's largest supplier of integral blinds, all Uni-Blinds® fully conform to the guidelines laid down by the British Blind and Shutter Association and none of our products are recommended for installation with free hanging cords which is a major concern for families with children.

The risks are eliminated using Uni-Blinds® because the external cord mechanism is held securely against the double glazed unit and by using the bottom cord tensioner. A safety break is incorporated into the top external magnetic device. Uni-Blinds® 1600mm high and above are supplied with a standard cord length of 1000mm with other lengths available on request.

Morley Glass & Glazing is the only UK integral blind manufacturer and supplier affiliated with the BBSA.



Uni-Blinds®, members of the British Blind and Shutter Association



Tensioner

This holds the cord securely against the glass so that it is out of reach from children. The cord/chain is then secured as shown in the image opposite.

Thanks to their patented automatic release system, Uni-Blinds® eliminate the risk from looped blind cords and chains.



THE REVOLUTION IN INTEGRATED BLIND SYSTEMS

First integrated blind system in 16mm cavity

- Exclusive 10mm slats
- Every component expressly designed for a 16mm cavity
- IG units with SL 16 integrated blind systems can be installed without replacing most existing window frames

Available in

S102
WHITE
Standard

S149
CREAM
Standard

S157
SILVER
Standard

SL16C BLINDS EXCLUSIVE

Lifespan
20,000 full up & down cycles "C" systems certified TÜV

Clean lines
Lack of plastic joints between internal components ensures formal simlicity

Thermal performances
Thermal break head rail (madeup of 2 coupled parts)

Energy
Patented warm edge spacer bars

Accuracy
Patented bottom rail self-adjustment device

Safety
Patented automatic release system of control device complies with child safety standards

Versatility
External motor, knob and wand control devices available as options

User friendliness
Tilting & raising operation by means of a cord loop

Applications
Slim control devices allow application to all types of window frames, even sliding ones

SL16S BLINDS

Patented technology
Patented-pending system of internal cord winding on tube reduces the blind friction

Clean lines
Lack of plastic joints between internal components ensures formal simlicity

Energy
Patented warm edge spacer bars

Accuracy
Patented bottom rail self-adjustment device

Lifespan
Closed-loop belt transmission system allows smooth and long-lasting function

Thermal performances
Thermal break head rain (made up of 2 coupled parts)

Hygiene
External slider treated with **Sanitized®** patented antibacterial finish

Applications
Slim control devices allow application to types of window frames, even sliding ones

User friendliness
Tilting & raising operation by means of one magnetic slider



B System

B SYSTEM

The B System is the new patented manual magnetic blind system manufactured by Uni-Blinds® and available from Morley Glass & Glazing. The Venetian blinds are encapsulated within a 20 or 22mm cavity with tilt only function.

The external magnetic device is placed on the glass on the lower based rail. Motion is transmitted via two gears located in the top and bottom corner keys of the blind, which are connected to each other by means of a shaft which is completely concealed inside the spacer bar.

The system is particularly suitable for windowsill applications, such as structural facades, hospital wards and schools as the control device is located at the bottom of the blind, making it readily accessible from a low level or seated position.

P System



P SYSTEM

The P System comprises a Venetian blind incorporating a 12.5mm slat designed to be integrated in a double glazed unit with a 20mm cavity.

The manual tilt only function is operated via a wire drive by an external knob. The specially designed corner key containing the rotational magnet is connected to the external knob by a flexible drive cable located within the glazing cavity of the window frame. Due to the narrow cavity (20mm), the system can be used in almost all types of existing window frames, whilst the special design allows the aesthetic quality to be maintained in whatever environment it is installed. The only visible control is the external knob fixed to the window frame, allowing the glass surface to remain completely free and easy to clean.

These particular features make the P System ideal for public environments such as hospitals or government offices where a variety of people need to operate this simple but highly protected system. It can also be modified to incorporate a 16mm slat for integration in a 24mm cavity unit.



Knob choices



Plastic antiligature knob colour choices.



Antiligature knob stainless steel.

GLASS



High Performance SKN176

Glazing options



QUALITY AND HERITAGE



All our glass is supplied by GLASSOLUTIONS, the UK's largest processor, distributor, installer and repairer of glass and glass systems. The company has a long heritage of manufacturing glass and is part of the global building products company Saint-Gobain, which is more than 350 years old. GLASSOLUTIONS provides Morley Glass and our customers with the best of worlds – solid financial foundations and technical back-up, plus the flexibility and autonomy to best meet the needs of the UK market.

Saint-Gobain is present in 64 countries and employs over 190,000 people worldwide, including over 17,000 in the UK & Ireland. It was founded in 1665 to deliver a world first – the production of glass on an industrial scale – and has continued to grow its business via the ongoing development of new services, products and ways of working with customers.

As one of the world's top 100 innovators, Saint-Gobain spends €400m a year on R&D globally, tackling some of the biggest challenges of our time. One in five products manufactured by Saint-Gobain did not exist five years ago.

In the UK and Ireland, some of the best known and respected companies in the construction sector are part of the Group, including British Gypsum, Isover, Glassolutions, Saint-Gobain Weber, Saint-Gobain Glass, Saint-Gobain PAM, Pasquill, Celotex and Ecophon. Together they offer a range of high performance energy-saving products and solutions to help create a more sustainable built environment.





GLAZING INNOVATIONS



Technologically advanced glazing provides year-round comfort, keeping you warm in winter and cool in summer.



All sealed units and Uni-Blinds® from Morley Glass & Glazing provide the optimum combination of insulation when you need it, while preventing rooms over-heating during the summer.

We make this possible by using only the UK-made Planitherm series of glass supplied by industry-leading glass processor GLASSOLUTIONS. Planitherm is a family of high-performing low-E glass products with several options to best suit the multi-functional demands on any window, door, conservatory or façade.

Double and triple glazed sealed units are available featuring:

- Planitherm Total+
- Planitherm One
- Planitherm 4S
- SKN 176 II.

The exact SKN specification of your sealed unit will depend on the application, not least the size and orientation of the window or door. So we're here to provide all the support our customers need to achieve the best result.

The Planitherm series is used for all our EcoClear Plus double and triple glazed sealed units which deliver windows and doors with wide ranging aesthetic and comfort benefits:

- Helps to eliminate cold areas around windows resulting in greater comfort
- Reduces incidence of condensation on the inner pane
- Neutral appearance in both transmission and reflection
- Maximises entry of natural daylight
- Maximises use of living and working areas.

PLANITHERM TOTAL+

The difference is clear with Planitherm Total+. This high quality glass combines excellent thermal performance with the ultimate in clarity thanks to a microscopically thin coating which is virtually invisible.

Planitherm Total+ sealed units are perfect for general fenestration requirements being compatible with achieving A Window Energy Ratings (WERs).

SGG Planitherm Total+ is one of the most energy efficient window glass products available today.

Enhanced thermal insulation

Double glazed units incorporating SGG Planitherm Total+ offer up to three times more insulation than standard double glazing and significantly better thermal insulation compared to hard coated low-E products:

- Considerable reductions in heating bills
- Eliminates cold areas around windows
- Maximises the amount of natural light into the home, without haze or tint effects
- Helps to reduce condensation on the inner pane
- Environmentally friendly solution, given the lower CO2 emissions associated with reduced energy consumption
- Ensures compliance with current Building Regulations requirements for all frame types or designs
- Exceptional Window Energy Rating performance thanks to the optimised balance between a very low U-value and even higher solar gain.



Technical specifications

Performance Data	DGU		TGU	
Internal Pane	SGG PLANITHERM TOTAL+			
External Pane	SGG PLANICLEAR	SGG DIAMANT	SGG PLANICLEAR	SGG DIAMANT
Composition in mm	4(16)4		4(16)4(16)4	
Low-Emissivity Coating Position	Face 3		Face 3/5	
Light Transmission	81%		72%	73%
Light Reflectance	12%		16%	
LRi	13%		16%	
T	64%	66%	52%	53%
RE	20%	21%	25%	26%
A1	6%	3%	6%	3%
A2	9%	10%	11%	11%
A3	-	-	6%	7%
g-value	0.73	0.75	0.63	0.64
Shading Coefficient	0.83	0.86	0.72	0.74
U-value in W/m ² K** - Air	1.4		0.8	
90% Argon	1.2		0.6	

SGG PLANITHERM TOTAL+ meets the durability requirements of class C of European standards EN 1096 and is marked.
 * Light and solar performance according to EN 410.
 ** Centre-pane U-values have been rounded in accordance with EN 673.
 For Window Energy Ratings simulators should calculate whole window U-values from first principals using normal surface emissivity (ε = 0.05).

MORE LIGHT

Planitherm has the best light transmission properties compared to all competitor products

No unsightly tint or 'haze' effect – unlike traditional low-E coatings that suffer from an unsightly yellow tint, Planitherm Total+ looks very clear. This means your curtains or Georgian Bars will not look dirty or discoloured. More light – less tint also means more light can enter the room, making it more comfortable and luminous.



PLANITHERM ONE



Superior performance “single-stock” low-E glass with an optimum centre-pane U-value of 1.0 W/m²K

Designed specifically to minimise heat loss, Planitherm One is ideal for achieving the lowest U-values. The advanced coating of Planitherm One offers insulating levels far in excess of the minimum requirements set out in Approved Document L of the Building Regulations.

A double glazed sealed unit featuring Planitherm One will deliver an optimum centre-pane U-value of 1.0W/m²K (16mm, 90% argon-filled cavity). This can help with any new build project, especially those in which permissible trade-offs are sought to meet overall performance requirements for a dwelling.

SGG PLANITHERM ONE represents the most advanced thermal insulation performance within the SGG PLANITHERM family, Europe’s best selling low-emissivity (low-E) glass and one of the UK’s leading offline low-E coating brands.

Comfort and Aesthetics

- Helps to eliminate cold areas around windows resulting in greater comfort
- Reduces incidence of condensation on the inner pane
- Neutral appearance in both transmission and reflection
- Maximises entry of natural daylight
- Maximises use of living and working areas.

Enhanced thermal insulation

- With an optimum centre-pane U-value of 1.0W/m²K (16mm, 90% argon-filled cavity), SGG PLANITHERM ONE T can comfortably meet current Building Regulations by improving whole window U-values for all frame types
- Particularly suited to residential new build and light commercial new build and renovation applications using steel and aluminium frames
- Considerable reductions in heating over standard glass
- Maximises entry of natural daylight
- Environmentally friendly solution, given the lower CO₂ emissions associated with reduced energy consumption.



Superior performance “single-stock” low-E glass with an optimum centre-pane U-value of 1.0 W/m²K

Designed specifically to minimise heat loss, Planitherm One is ideal for achieving the lowest U-values. The advanced coating of Planitherm One offers insulating levels far in excess of the minimum requirements set out in Approved Document L of the Building Regulations.

A double glazed sealed unit featuring Planitherm One will deliver an optimum centre-pane U-value of 1.0W/m²K (16mm, 90% argon-filled cavity). This can help with any new build project, especially those in which permissible trade-offs are sought to meet overall performance requirements for a dwelling.

PLANITHERM 4S



There is no better glazing solution for conservatory side walls than Planitherm 4S. It offers a high level of thermal insulation in colder months but with the benefit of being able to manage the risk of excess heat gain even in the strongest, direct summertime sunshine.

That's why we call it 4 Seasons – whatever time of year, Planitherm 4S has the right blend of multi-functionality to provide an effective solution.



Product applications

SGG PLANITHERM 4S is designed for use in double glazing applications, in all frame types for both residential new-build and replacement markets:

- Windows and skylights in residential buildings and private domestic housing
- Conservatories and patio doors.

Advantages

- Thermal insulation: reduces heat loss more effectively than traditional low-E products
- Solar protection: reflects up to 56% of solar heat gain through conservatory sidewalls and as much as 79% when used in conjunction with SGG BIOCLEAN AQUA in the roof areas
- Energy efficient: reduced need for heating and cooling protects the environment and saves you money
- Visual comfort: maximising natural light and reducing glare provides an enhanced level of visual comfort
- Neutral appearance: beautiful neutral appearance matches the rest of your glazing.

KEEP COOL IN SUMMER

For ROOFS when combined with special dual-coated self cleaning and solar control glass

Heat reflection 71%
Glare Reduction

If used alone in a DGU for sidewalls

Heat reflection 57%
Attractive neutral appearance

KEEP WARM IN WINTER

For ROOFS when combined with special dual-coated self cleaning and solar control glass

Less heat loss compared to ordinary double glazing 63%

Reduced condensation

Save pounds on your heating bills

Cold spots and drafts reduced

Unbeatable thermal insulating U- Value of 1.0 W/M²K



SKN 176 11



Combining high performance solar control with excellent neutrality, for applications requiring high light transmittance combined with a low g-value.

PERFORMANCE DATA

Internal Pane	SGG PLANICLEAR
External Pane	SGG COOL-LITE SKN 176 II
Composition in mm	6(16)6 & 4(16)4
Coating Positions	Face 2
LT	70%
LRe	13%
LRi	15%
g-value*	0.37
Shading Coefficient	0.43
U-Value in W/m2K Air	1.3
90% Argon	1.0



DESCRIPTION

SGG COOL-LITE SKN 176 II is a solar control product that features a high performance coating. The coating is applied to SGG PLANICLEAR oat glass by cathodic sputtering under vacuum conditions.

SGG COOL-LITE SKN 176 II forms part of the ever-evolving range of 'to be toughened' neutral solar control coatings from SAINT-GOBAIN GLASS.

In order to achieve its superior thermal properties, solar control performance and neutral appearance, SGG COOL-LITE SKN 176 II must always be toughened or heat-strengthened before assembly into a double-glazed unit.

BENEFITS

SGG COOL-LITE SKN 176 II balances the advantages of a high performance neutral solar control product with:

- High light transmission 70%
- Low g-value of 0.37
- Excellent U-value of 1.0W/m2K
- High degree of neutrality.

SGG COOL-LITE SKN 176 II can be used to create more comfortable interiors by reducing overheating and the need for costly air conditioning, whilst at the same time noticeably reducing excessive heat loss.

The high light transmittance also reduces the requirement for interior lighting during daylight hours, helping reduce energy costs even further.

APPLICATIONS

SGG COOL-LITE SKN 176 II is a solar control coating for use in residential or commercial buildings, either for façades or overhead glazing. Due to the unique properties of the coating, it is ideally suited to applications requiring a high light transmittance, low g value and excellent neutrality.

The 4mm option allows the product to be used in applications such as high end residential / low end commercial applications. This extended functionality allows more design flexibility whilst retaining excellent neutral aesthetics.

SGG COOL-LITE SKN 176 II meets the durability requirements of class C of European standards EN 1096-1 and -2. * Light and solar performance according to EN 410.

4MM OPTION NOW AVAILABLE

SGG COOL-LITE and SGG PLANICLEAR all other devices and logos are registered trademarks of Saint-Gobain.



CONSERVATORY GLASS



See the possibilities and feel the benefits with year round comfort. Your choice of glass for the roof and vertical glazing will have a major impact on the overall feel and comfort of your conservatory.

The potential uses of a conservatory are as diverse as the designs available. Some are looking to add extra living space that can be used year round as a dining room, children's playroom, home office or similar, while others are looking to create a seamless, visually connected link between home and garden.

Conservatories can offer a bright and airy place to relax and enjoy uninterrupted views of outside whilst maintaining a comfortable inside ambience.

When choosing a conservatory you need to ensure that it will match your own specific lifestyle requirements and it is here that the right choice of glass is key. By considering a combination of SAINT-GOBAIN GLASS products and tint finishes you can create the conservatory that is perfect for you.



HEAT REFLECTION:

Measured by taking the opposite or inverse of the glazing solar factor. Solar Factor is the percentage of the total solar radiant heat energy entering the room through the glass. Reflects up to 78% of the sun's heat, keeping the conservatory up to 9°C cooler in the summer.



THERMAL INSULATION:

A measure of the rate of heat loss through the glazing. A principle reason for installing energy efficient glass, the lower the U-value the better the glass is at retaining heat. 63% better insulation than standard glass, keeping you warmer in winter and saving you money on your heating bills.



SELF-CLEANING GLASS:

The self-cleaning coating is fully integrated into the surface of the glass ensuring its permanency. In a process called 'catalysis' the coating uses UV rays from the sun to break down organic dirt and turns the surface hydrophilic. Rain or hose pipe water then forms a sheet of water and rinses the dirt away, reducing the need for manual cleaning. Also prevents water droplets from forming which means clear views, even when it's raining.



GLARE REDUCTION:

Measured by the inverse of 'light transmission', the proportion of the visible light spectrum that is transmitted through the glass. It is important to reduce the transmission of concentrated light, especially in the roof, to maximise visual comfort. Reduces up to 68% of the sun's glare, maximising visual comfort on the brightest of days. Like sunglasses for your roof!



VIRTUAL ELIMINATION OF CONDENSATION:

Internal condensation will only begin to form at an average external temperature of -11°C (in timber/PVCu frames at an internal temperature of 20°C and 50% relative humidity).

Choosing the right glass is perhaps one of the most important decisions that you will need to make, but it needn't be a tough one.

The following comparison chart is designed to help you choose the perfect combination of SAINT-GOBAIN GLASS products that will enable your new conservatory to exactly match your specific criteria.

Application	Inner pane	Outer pane	Heat reflection	Glare reduction	U-values	Reduced condensation	Naturally self-cleaning
Roofs	Bioclean AQUA	Planitherm 4S	78%	68%	1.0 (W/m ² k)	✓	✓
Roofs	Bioclean NATURA	Planitherm 4S	71%	63%	1.0 (W/m ² k)	✓	✓
Roofs	Bioclean AZURA	Planitherm 4S	67%	53%	1.0 (W/m ² k)	✓	✓
Roofs	Bioclean SOLARA	Planitherm 4S	66%	58%	1.0 (W/m ² k)	✓	✓
Roofs	Planitherm 4S	Float glass	57%	35%	1.0 (W/m ² k)	✓	



Conservatory glass

NORMAL GLASS



BIOCLEAR GLASS

BIOCLEAR SELF-CLEANING CONSERVATORY ROOF GLASS

Enjoy the view without the hassle of cleaning your conservatory roof

Our BIOCLEAR self-cleaning glass option is the perfect way to make use of technology to cut down on maintenance and cleaning hassles.

This revolutionary self-cleaning coating is applied to the glass as part of the manufacturing process. This means it is fused to the surface of the glass and therefore lasts the lifetime of the pane.

The special BIOCLEAR coating uses both rain and natural light from the sun to efficiently combat the dirt and grime that accumulates on the outside of the window. By significantly reducing the need for manual cleaning, it provides the ideal solution for keeping those hard or dangerous to reach areas clean, leaving householders with more time to relax and enjoy the view.

Tint options:

Available in a choice of four tint options for your conservatory roof to match your precise specification requirements.

How BIOCLEAR self-cleaning glass works

There are two processes at work:

- The special coating harnesses natural daylight which triggers the breakdown of the dirt and grime on the outer surface of the glass.
- When rainwater hits the glass, rather than forming droplets it flattens and spreads out across the surface of the glass helping to wash away the loosened dirt and grime. This sheeting effect also minimises spots and streaks by helping the glass to dry more quickly and evenly.

Self-cleaning glass advantages

- The permanent self-cleaning coating lasts the lifetime of the window
- Perfect for conservatory roofs and other hard to reach areas
- Glass stays cleaner for longer
- Less dirt and grime adheres to the glass so any cleaning is quick and easy
- Ongoing cost savings with reduced window cleaning bills
- Kinder to the environment with a less frequent use of water and detergents
- Clear view outside even when it's raining thanks to the sheeting effect.



AQUA
A pleasant, relaxing aqua green appearance to complement interiors and surrounding natural garden tones.



NATURA
A virtually neutral glass to complement existing glazing.



AZURA
An attractive blue tint.



SOLARA
A bronze tint which is ideal for timber and dark conservatory frames.

NON-STICK GLAZING THROUGHOUT YOUR HOME

Reduce window cleaning with ClearShield protection

We offer a superb solution for all windows and doors which takes away the hassle of frequent cleaning and keeps them looking good as new for longer.

All our sealed units are available with Ritec's award-winning ClearShield System. This has been specially developed for the protection, renovation and maintenance of both new and already installed glass.

Just like a non-stick frying pan, ClearShield provides a protective barrier for the surface of glass that is much more effective than a coating. It cuts the amount of window cleaning you will need to do by up to 70% without affecting the transparency or solar gain (g-value) of the glass.

ClearShield protected glass:

- Is always easier to clean and keep clean
- Stays cleaner for longer
- Resists staining and discolouration.

Remember, the benefits of ClearShield protection are not restricted to new sealed units – we can upgrade existing windows too.



NORMAL GLASS

Factory or on-site application

Morley Glass & Glazing is approved and fully trained by Ritec to apply ClearShield. It is applied to glass onsite for glass already installed or in the factory onto new glass.



SELF-CLEAN GLASS

Backpainted glass



BACKPAINTED GLASS

The must-have kitchen and bathroom feature

High quality backpainted glass adds that special appeal to any contemporary kitchen or bathroom, making an impression that other materials simply can't match.

We supply back painted glass in virtually any colour with superb glass clarity thanks to our base material being a low iron float glass. We'll match any RAL, Syntha Pulvin or Dulux colour code as closely as we possibly can for perfect coordination in any room.

We work directly with homeowners, as well as kitchen and bathroom designers/installers, builders and architects, to advise on backpainted glass specification and the product's suitability for applications.

Backpainted glass is perfect for kitchen splashbacks, worktops, feature panels for walls, architrave, skirting boards, shower panels and almost any smooth, fixed element within the home.



Application, specification and installation guidance

With the colour coating on the reverse, the glass is easily cleaned, very durable and when painted on toughened glass is heat resistant to approximately 200 degrees Celsius – that's ideal for use behind an oven or wood burner.

Backpainted glass can be easily fixed to the wall with mirror adhesive (although products like Gripfill, No Nails etc, must NOT be used under any circumstances). Alternatively, as long as it has been specified at the time of order, the glass can be drilled and screwed to the wall with dome top mirror screws.

Measure up where you need cut outs for sockets, switches, etc before you place an order and we'll cut these ready for installation – complicated shapes can be accommodated too.

The advantages are clear

PEACE OF MIND

Our highly experienced and skilled team provides you with the assurance that orders are handled efficiently, accurately and professionally from the moment we take your enquiry through to post-installation support.

Our manufacturing excellence is recognised by the fact that we are the only company in the UK licensed to manufacture ScreenLine® blinds in-house. We use bespoke precision engineered machinery to give a perfect finish every time and combine this with craftsmanship. All our Uni-Blinds® operatives have been trained in Italy by Pellini to exacting standards in blind fabrication.

Every Uni-Blinds® unit is tested after fabrication to ensure smooth operation and trouble-free installation. This includes our 'plug n play' pre-wired boxes supplied with motorised Uni-Blinds®. A final quality control check on every product is completed before dispatch.

All our Uni-Blinds® units carry a five year guarantee in the glazing unit and on the integral blind components.



The must-have kitchen and bathroom feature

High quality backpainted glass adds that special appeal to any contemporary kitchen or bathroom, making an impression that other materials simply can't match.

We supply back painted glass in virtually any colour with superb glass clarity thanks to our base material being a low iron float glass. We'll match any RAL, Syntha Pulvin or Dulux colour code as closely as we possibly can for perfect coordination in any room.

We work directly with homeowners, as well as kitchen and bathroom designers/installers, builders and architects, to advise on backpainted glass specification and the product's suitability for applications.

Backpainted glass is perfect for kitchen splashbacks, worktops, feature panels for walls, architrave, skirting boards, shower panels and almost any smooth, fixed element within the home.



All our Uni-Blinds® sealed units incorporate ScreenLine® blinds – this is the world's number one product of this kind. Morley Glass is in fact Europe's largest manufacturer of ScreenLine® blinds, reflecting the strength of our position in the integral blinds market and manufacturing expertise.

Testimonials



Ian Short, Managing Director of Morley Glass & Glazing with Alessandro Pellini, Worldwide Commercial Director of Pellini S.p.A. in Codogno.

“ Many thanks for all the help and assistance yesterday, the blinds are working perfectly. Can you please pass on my thanks to Ian for his persistence in achieving a fully operational system. ”

YOUR OPINION MATTERS

“I would like to thank you for the excellent service I have received from your company. Thanks for sending your engineer down to look at the installation, he was able to fix one on-site and arranged for a new unit to be manufactured to replace the other.”

Advanced Alloys Limited

“Our partnership with Morley Glass is a vital component to maintaining the exceptionally high standards we set ourselves, both in customer service and in the high quality of our bespoke products - we are pleased to endorse the whole team at Morley Glass who always provide a fantastic service, a quick response time and great after sales service. We need suppliers who offer the same high standards and are willing to help and offer reliability. Morley Glass never fail to impress.”

Sunfold Systems Ltd

“Because we purchase integral blinds as complete encapsulated units from Morley Glass & Glazing Ltd, we have totally eradicated any manufacturing issues and have the peace of mind of knowing that their Uni-Blinds® product is fully guaranteed for five years. A deciding factor in our decision was that we also have the support of their highly experienced Service Engineer should we need advice or a site visit after installation.”

Alpine Window & Door Systems Ltd

NATIONWIDE SERVICE AND DISTRIBUTION

In addition to our stringent manufacturing processes and quality control checks, we are the only integral blind company in the UK to employ full-time service engineers.

This ensures that our clients and their end users have access to and the full support of our highly experienced engineers who are available to provide support on installation queries or advice on operation issues, once installation is completed. They are also available to attend on-site visits nationwide and will always endeavour to arrange a convenient time for your client.



NATIONWIDE DELIVERIES EVERY WEEK

SCREENLINE® accessories and spares when you need them fast.

Morley Glass stocks the biggest range of ScreenLine® accessories and spare parts in the UK. So when you need a part for our Uni-Blinds® or any ScreenLine® integral blind system, we'll make sure you have it within 24 hours. As the largest ScreenLine® fabricator in the country, we have regular daily deliveries from Pellini S.p.A.

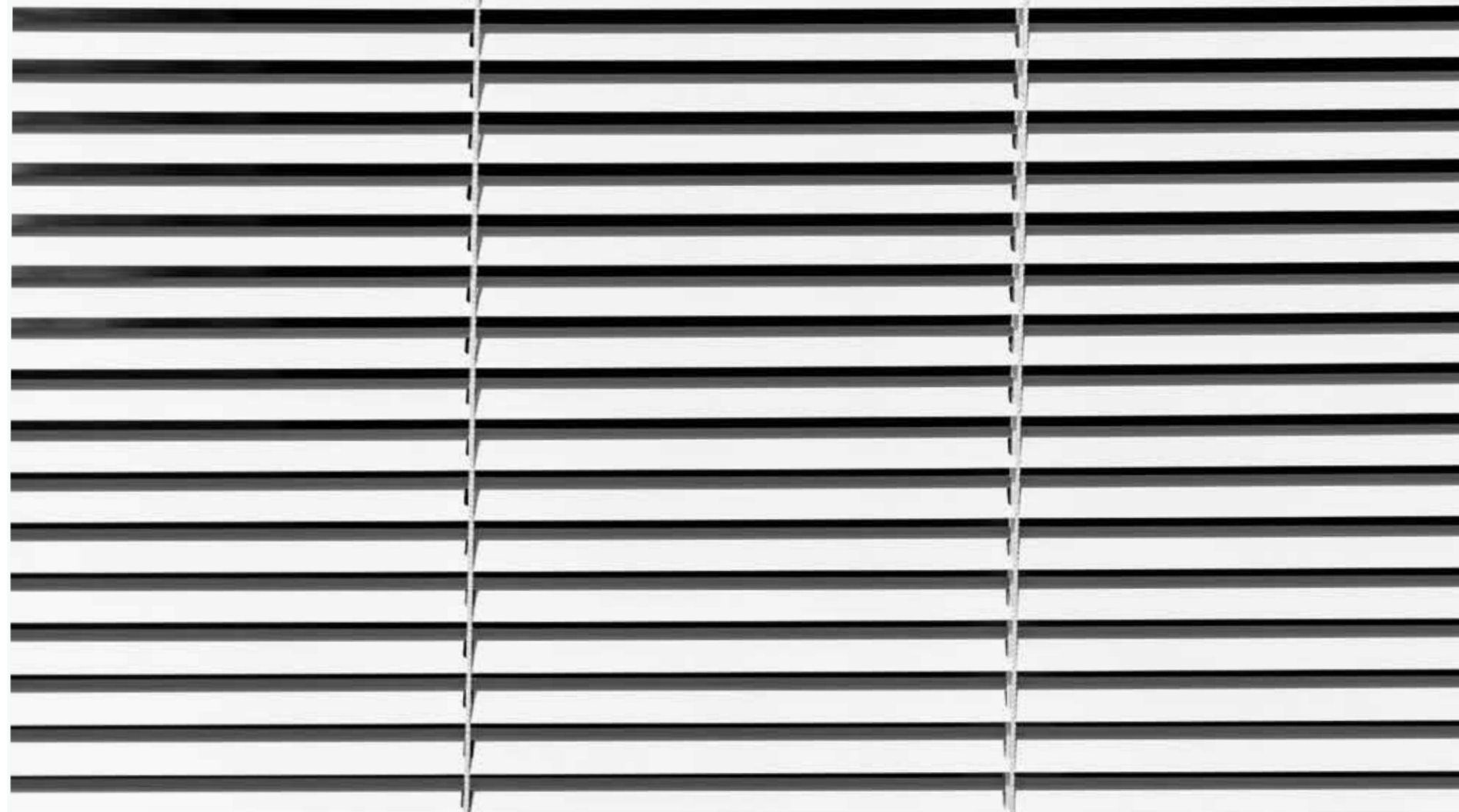

Please call 0113 277 8722 or email info@morleyglass.co.uk for copies of our retail brochure

Other publications available:

- Back painted glass brochure
- Conservatory glass brochure
- Decorative options for doors, windows and fanlights
- Retail brochure
- ScreenLine® Accessories brochure
- Lifestyle brochure

CALL OUR EXPERT AND FRIENDLY TEAM: 0113 277 8722

Mon - Fri 07:30 - 16:30

All technical information is available
on our website: morleyglass.co.uk



Uni-Blinds®

Innovation comes built-in



pellinindustrie



Morley Glass
Unit 3 Leeds 27 Industrial Estate,
Bruncliffe Way, Leeds, LS27 0HH
Email: info@morleyglass.co.uk
Tel: 0113 277 8722
Fax: 0113 277 8723